

*The American Gunmaker*

# JOHN M. BROWNING

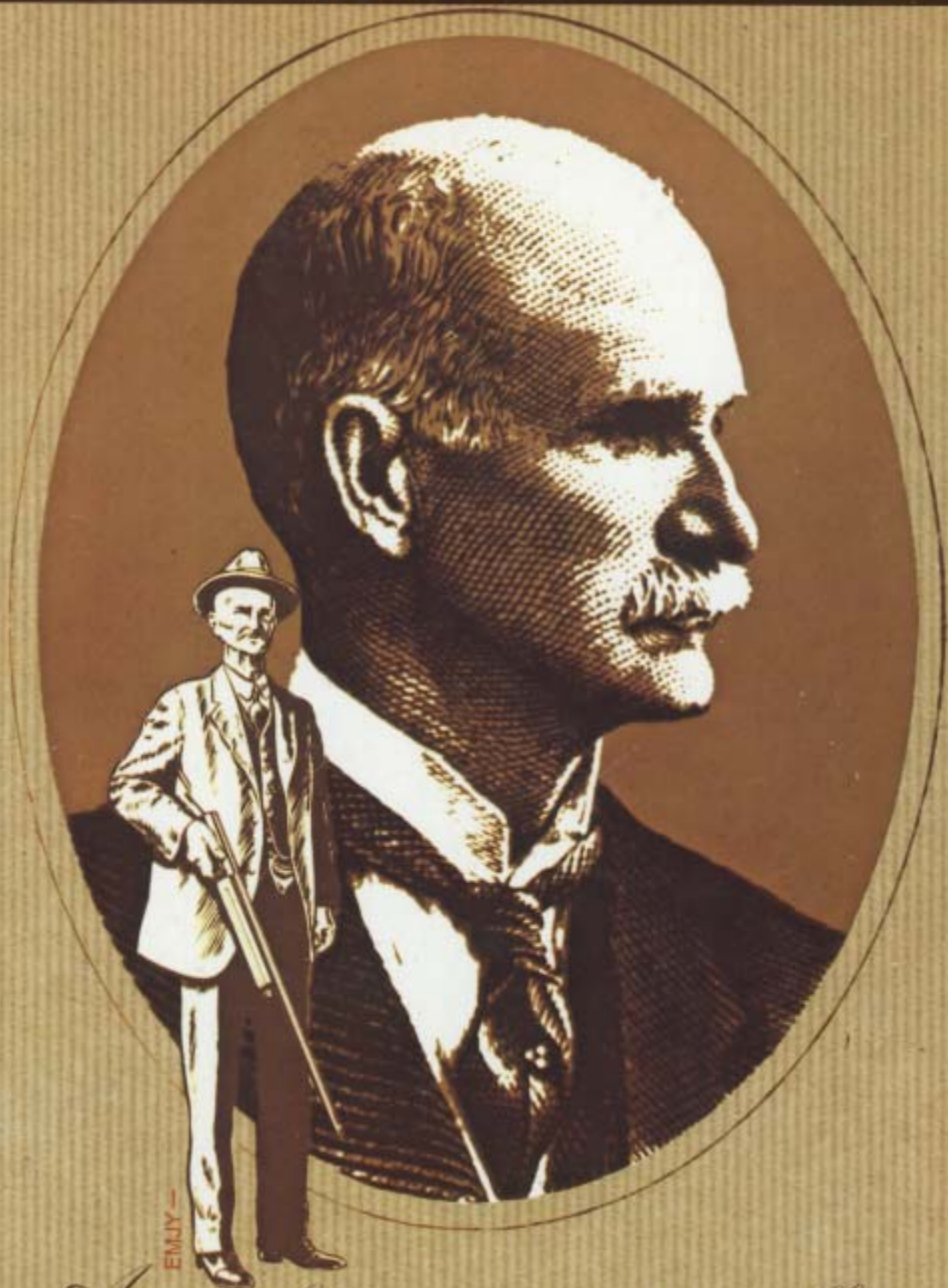

*A complete comic strip story album*







KEEP YER JOKES FOR YOURSELF, STRANGER ! HOW DID YOU GET OFF FIVE SHOTS BEFORE I COULD BAT AN EYE !!!



YOU'VE BEEN UP IN THE HILLS TOO LONG, PARDNER ! TAKE A LOOK !



I'LL BE DAMNED !

IT'S A FIVE SHOT ! LATEST MODEL !



WHO THE DEVIL INVENTED A SHOOTIN' IRON LIKE THIS ?

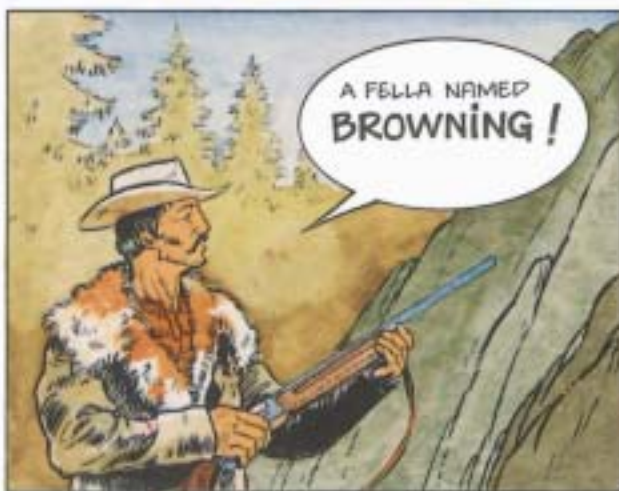

A FELLA NAMED **BROWNING** !



YOU OWE HIM A HELLIVA LOT !



YOU SAID IT, PARDNER !! I GOT A LONG TRAIL AHEAD OF ME ! SO LONG TO YOU, AND YOUR SHOOTIN' IRON !

*Captain John Browning came to America in 1622 aboard the Abigail and established one of the first families of Virginia. Many years later, in 1780, Edmund Browning, the grandfather of John Moses, moved to the Tennessee frontier and cut out a small farm near Brushy Fork.*

*It was in this area that his son, Jonathan, settled down to making guns in his own shop. However, in 1834, he closed the shop, loaded two wagons with his family and belongings and went off to Quincy, Illinois. This place was a small but flourishing town on the Mississippi, and Jonathan set up a new gunmaking shop. His business prospered and soon he was elected justice of the peace. Through his cousin Orvill, he met a young lawyer named Abraham Lincoln, the future president of the United States.*

*During the year 1840 a Mormon missionary converted Jonathan to the beliefs of the Church of Jesus Christ of Latter-Day Saints. The city of Nauvoo, 43 miles north of Quincy, which was a Mormon settlement, was still under construction when Jonathan with his family and tools moved in.*

*The city itself was founded in 1839 by the Mormon prophet, Joseph Smith. However, constant religious persecution and the assassination of the prophet forced the Mormons to leave the town on a cold winter's day and flee across the ice-covered Mississippi. The great westward drive began in 1846. Jonathan Browning set up his gunmaking shop south of Kanesville (Council Bluffs), Iowa. Once again, this was only a temporary stop, for in 1852 he loaded his family and tools into his wagons and rode farther west to the city of Ogden in Utah Territory, where he set up shop as a general mechanic and rough-and-ready engineer for the good of the community.*

*Jonathan Browning was not only a trailblazer but also an inventor who handed down to us the extraordinary Slide Repeating Rifle.*



THE MORMON EXODUS FROM  
NAILVOD, ILLINOIS TO  
SALT LAKE CITY, UTAH.

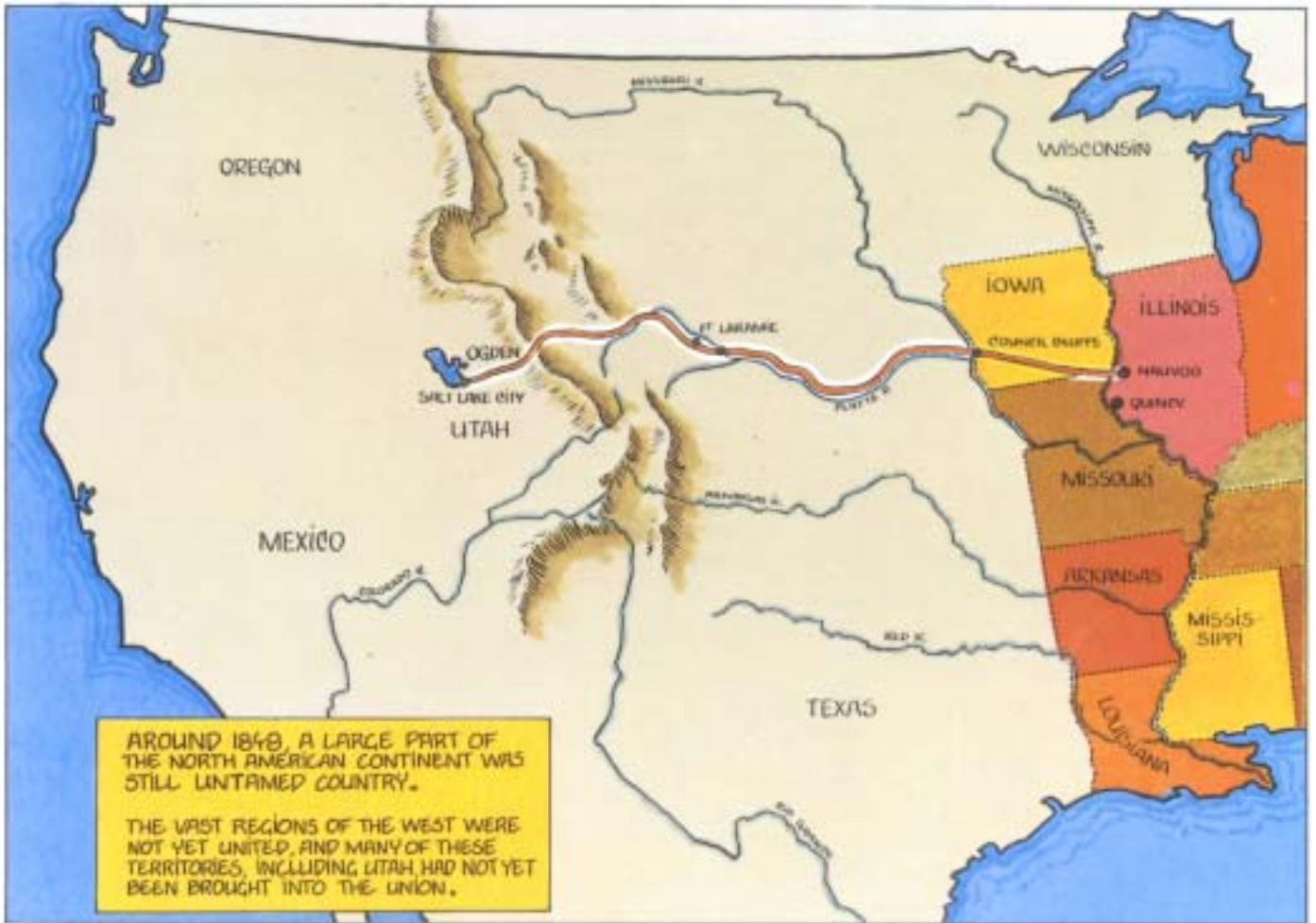

ON JANUARY 23, 1855  
IN JONATHAN BROWNING'S  
HOUSE, THE FIRST CRIES  
OF A NEW GENERATION  
WERE HEARD...

IT'S  
A BOY!

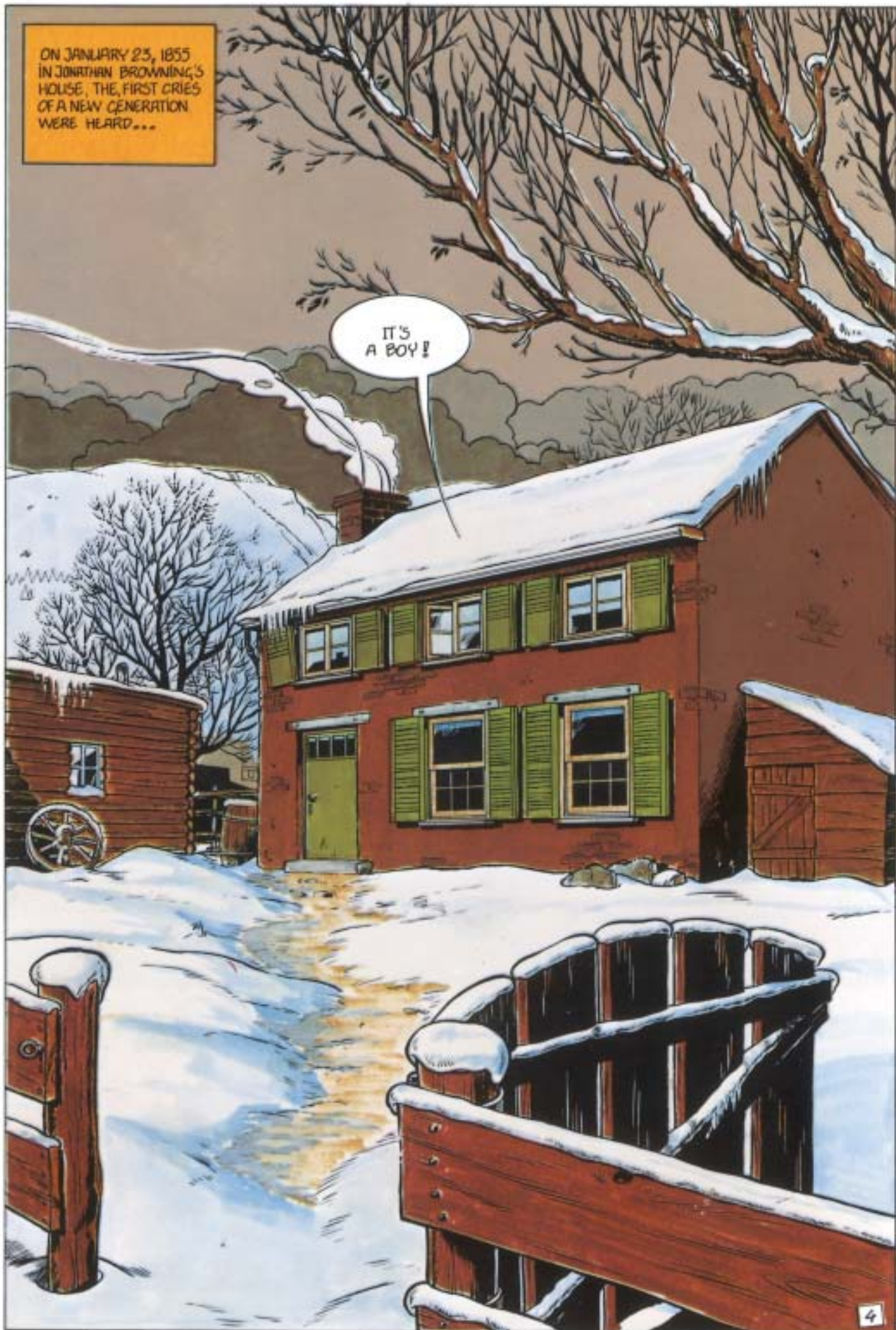





J. M. AT 10 YEARS OLD...



WITH HIS BROTHER MATT...

HOLD IT TIGHT, MATT!



LET'S TRY IT JOHN MOSE!



SWING THE CAN TO KEEP THE COALS HOT, WE'LL NEED THEM TO FIRE THE GUN MATT...

LOOK! PRAIRIE CHICKENS!



NOW!



THE SHOT GOES OFF...

**BOOM!**



NOT BAD FOR BEGINNERS!

THEY'RE THE BROWNING KIDS HAVIN' FLIN...







THE YEAR 1869 BROUGHT THE LONG AWAITED COMPLETION OF THE TRANSCONTINENTAL RAILROAD WHICH WAS STARTED IN 1863. TWO GREAT COMPANIES THE CENTRAL PACIFIC RAILROAD STARTING FROM CALIFORNIA (684 M.) AND THE UNION PACIFIC RAILROAD STARTING FROM OMAHA, NEBRASKA (1080 M.) LINKED UP AT PROMONTORY POINT, UTAH.

IN 1870 SALT LAKE CITY WAS CONNECTED TO OGDEN BY BRIGHAM YOUNG'S UTAH CENTRAL LINE.

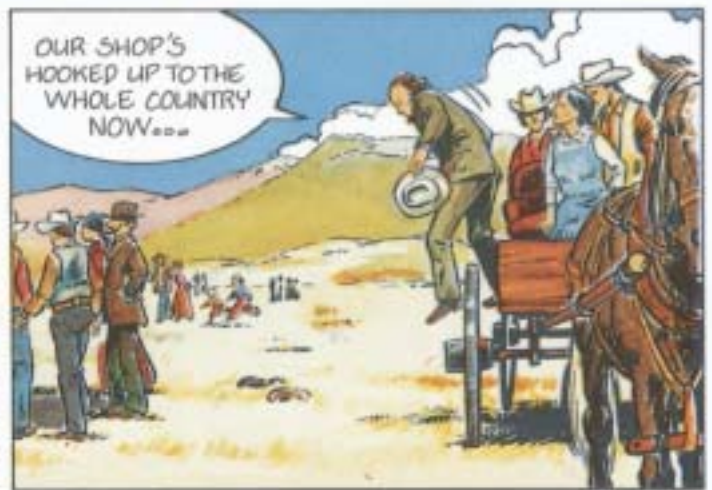

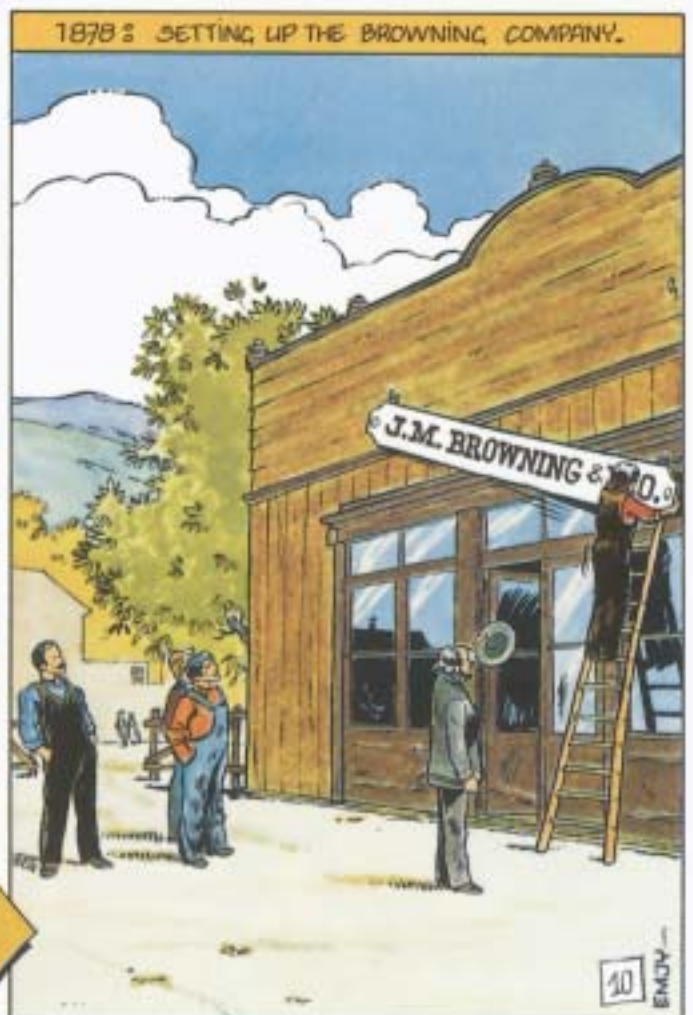

JOHN MOSES GETS DOWN TO WORK ...



SINGLE SHOT  
BREECH-LOADING  
RIFLE.



IT PASSED  
THE TEST !!

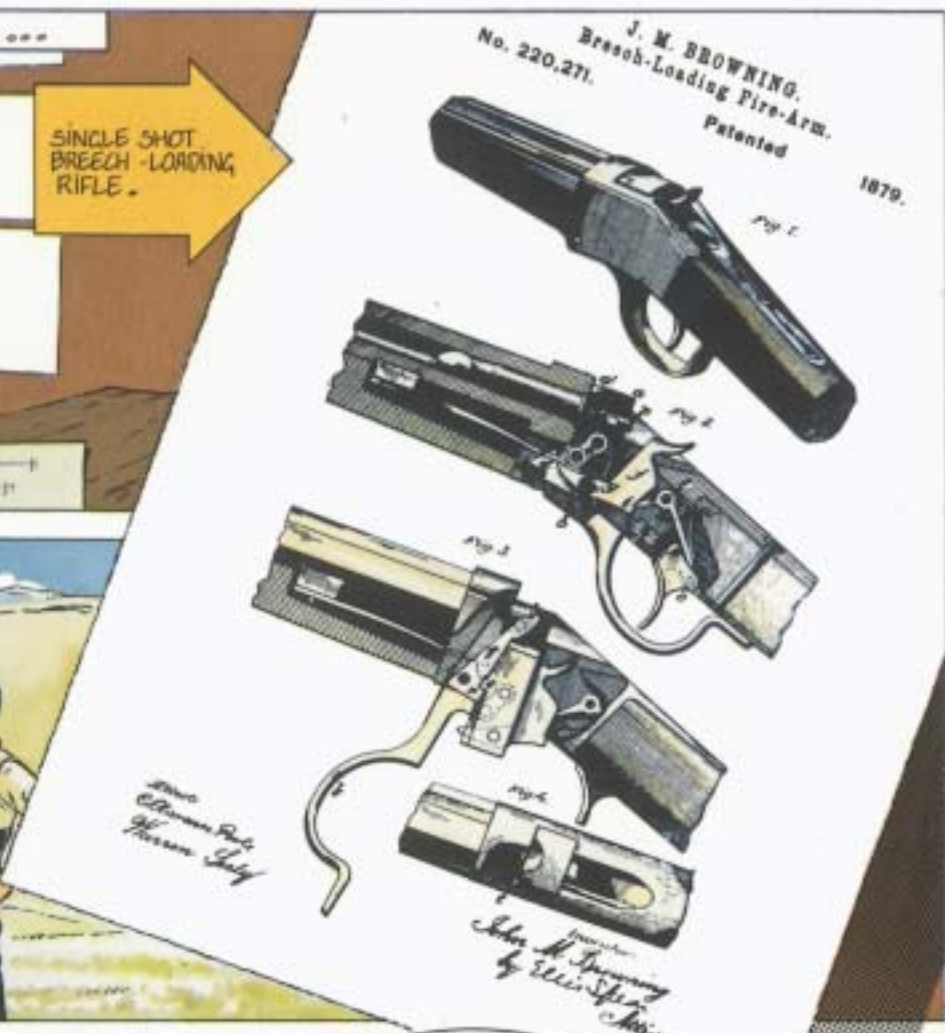

RACHEL  
TERESA!

JOHN MOSE  
...



WHY SURE,  
JOHN MOSES BROWNING  
I'M GLAD TO GIVE YOU  
MY DAUGHTER RACHEL'S  
HAND

AND  
I'M RIGHT  
PROUD OF IT !!

AND ON APRIL 10, 1879, JOHN MOSES  
BROWNING, AND RACHEL TERESA  
CHILD GET MARRIED.



WE CAN SET  
UP HOUSEKEEPIN'  
SOON !!

JOHN MOSE,  
RACHEL, COME  
HERE, FAST !!



OCBEN GREW FAST BECAUSE OF THE RAILROAD BOOM. JOHN MOSES'S GUNMAKING SHOP WHERE HIS BROTHERS WORK WITH HIM, BECOMES THE BIGGEST FIREARMS REPAIR CENTER IN THE WEST BETWEEN OMAHA, NEBRASKA AND THE PACIFIC OCEAN.

JOHN MOSES BROWNING AND HIS BROTHERS BUILD A NEW BRICK SHOP TO MANUFACTURE THEIR OWN SINGLESHOT RIFLE

THEY BUY A WOOD-FIRED 5 H.P. UPRIGHT STEAM ENGINE TO DRIVE THEIR MACHINES.

IN 1880 THE NEW SHOP STARTS RUNNING...





**BROWNING BROS.,**  
168 Main Street, OGDEN, UTAH.

—WHOLESALE and RETAIL—

**Firearms, Ammunition, Fishing Tackle, Tents,  
Hammocks and Base Ball Goods.**

In fact we have the largest stock and variety of Shooting and Sporting Goods to be found anywhere in the West at prices lower than any. We are also prepared to do all kinds of fine Gun or Machine work from an Engine or Thrashing Machine down at

**Reasonable Figures!**

**Illustrated Catalogues Free to Everybody!**



By West's Associated Press to the Herald.

SAN FRANCISCO, Sept. 26.—A special to the *Excaminer* from Tucson, Arizona, says the most intense excitement prevails in this city over the reported outbreak of the San Carlos Apache Indians. A courier arrived at San-tiam at noon to-day, notifying all the settlers in the valley that two bands had left the reservation and were marching south. This is supposed to be the result of the killing of Hosten. The post trader was murdered by the Indians yesterday, and intense excitement prevails along the valley. The outbreak here has to be of a very serious character. Already two bands are reported to be out, and of such is the case destruction will be wrought.

**A Cowboy Rumpus.**

Yesterday afternoon a couple of cowboys filled up on tarantula juice and then started to paint the town red. One of them ran his horse around on Fourth Street and ran against one or two buggies. Officer Brown called on him to desist, but the request was unheeded, and the uproarious fellow bolted off up Fourth Street hill, his companion following him. Sheriff Dehaap happened along with his horse, and he started in pursuit. He chased the couple up to the top of Fourth Street, along the bench and down to Main Street in way of Sixth. The rattierest cowboys then headed southward, the sheriff still in hot pursuit, the practicing the end of the Lane the others





JOHN MOSES TURNED OUT ONE INVENTION  
AFTER ANOTHER ...



BUT DIDN'T MANUFACTURE ALL OF THEM ...



MEANWHILE, AT THE WINCHESTER COMPANY ...



IN EXCHANGE WE ARE OFFERING YOU THE SOLE RIGHTS TO SELL OUR FIRE-ARMS AND SPORTING GOODS.



LATER ...

IN 1884, JOHN MOSES BROWNING DEVELOPS A LEVER ACTION REPEATING RIFLE WHICH IS TO BECOME THE MOST FAMOUS RIFLE IN AMERICA!

JOHN MOSES AND MATT GO EAST TO SHOW IT TO THE WINCHESTER COMPANY



GOOD LUCK, JOHN!  
GOOD LUCK, MATT!  
GOD BLESS YOU!

COME BACK SOON,  
JOHN MOSE!



JUST TAKE A LOOK AT THAT,  
MATT! THIS IS A REAL  
BIG COUNTRY!



THEY VISIT NEW YORK

GOOD GOD! WHAT A  
BIG CITY THIS IS! IT'S  
UNBELIEVABLE!

WINCHESTER DECIDES TO PRODUCE THE LEVER ACTION RIFLE (MODEL 86). BETWEEN 1885 AND 1887, WINCHESTER BUYS 20 PATENTS FROM BROWNING. THEIR ASSOCIATION WILL LAST UNTIL 1902.

FROM 1887 TO 1889, JOHN MOSES DOES MORMON MISSIONARY WORK IN GEORGIA...



MATT, ED,  
JOHN MOSE IS  
BACK!!



YOU AIN'T  
CHANGED A BIT!

RACHEL, MATT, EVERY  
BODY! IT'S GREAT  
TO BE HOME  
AGAIN!

WELL, YOU FINALLY CAME  
BACK TO US! BETTER DAYS  
ARE ACOMIN'!



THE OGDEN RIFLE CLUB IS  
ORGANIZING A SHOOT  
ALONG THE RIVER FRONT,  
WHY NOT  
COME WITH US,  
JOHN?

OK, ED!  
LET'S GO!



LOOK UP THERE,  
THEY'RE SHOOTIN'  
ALREADY!



HEY!

BANG



LOOK AT THOSE WEED-TOPS  
SWAY WHEN HE SHOOTS! IT'S  
BLOWN ASIDE BY GAS COMING  
OUT OF THE RIFLE ...



WHAT THE...?

THAT GAS WON'T BE LOST  
ANY MORE! I'VE GOT AN  
IDEA, COME ON HOME!



WE CAN USE THAT  
GAS ENERGY!  
IF I CAN ONLY FIND  
A WAY TO ...



... UTILISE THAT GAS TO  
PUSH ANOTHER CARTRIDGE  
INTO THE BREECH ...



... I'LL HAVE INVENTED  
AN AUTOMATIC RIFLE!

TERRIFIC!



THE NEXT DAY ...

IT'S READY!  
IT'S GOTTA WORK!

THE PATENT FOR A GAS-OPERATED SEMI-AUTOMATIC WEAPON IS APPLIED FOR IN 1890.  
THIS INVENTION IS THE FORERUNNER OF THE BROWNING MACHINE GUN OF 1895.

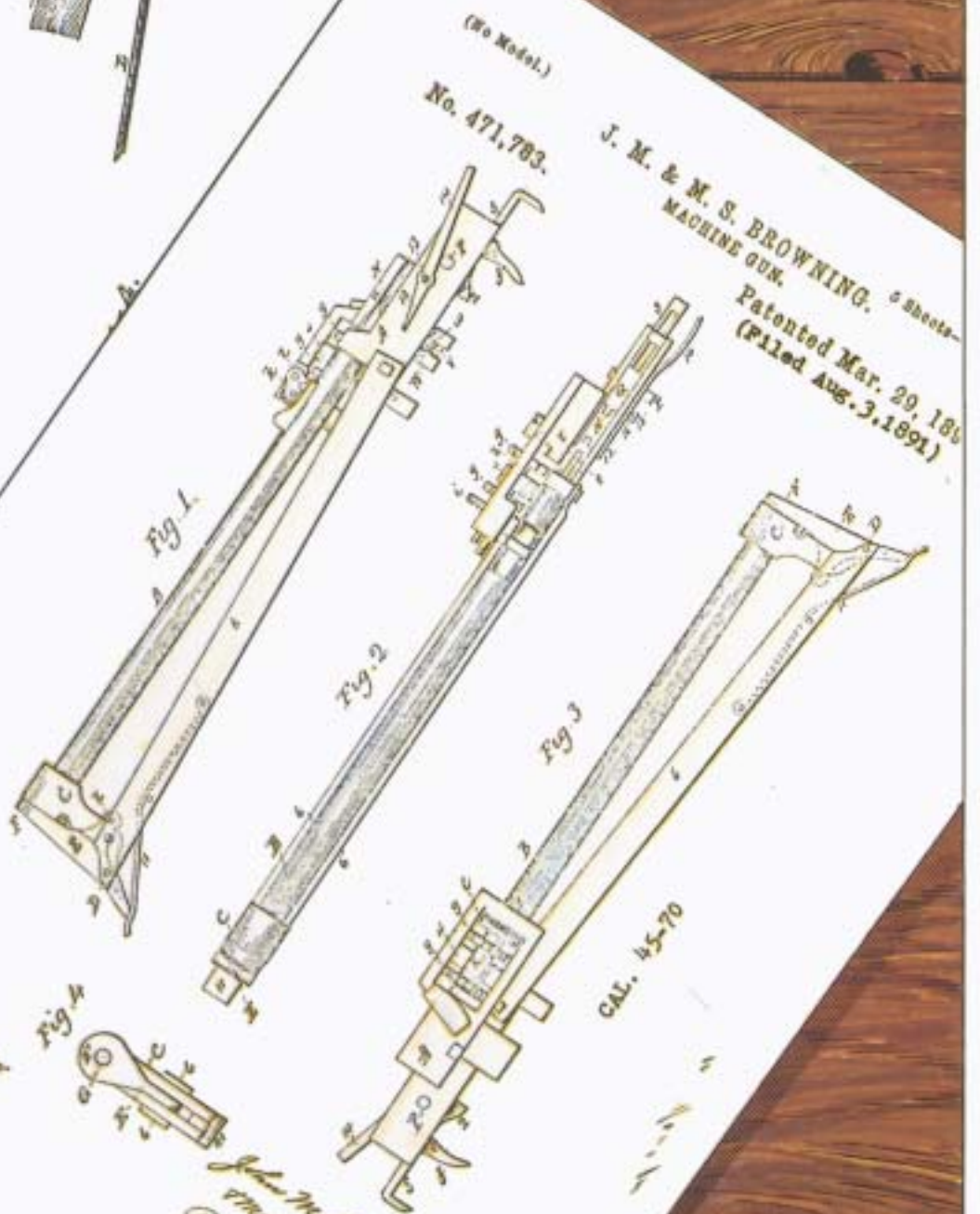
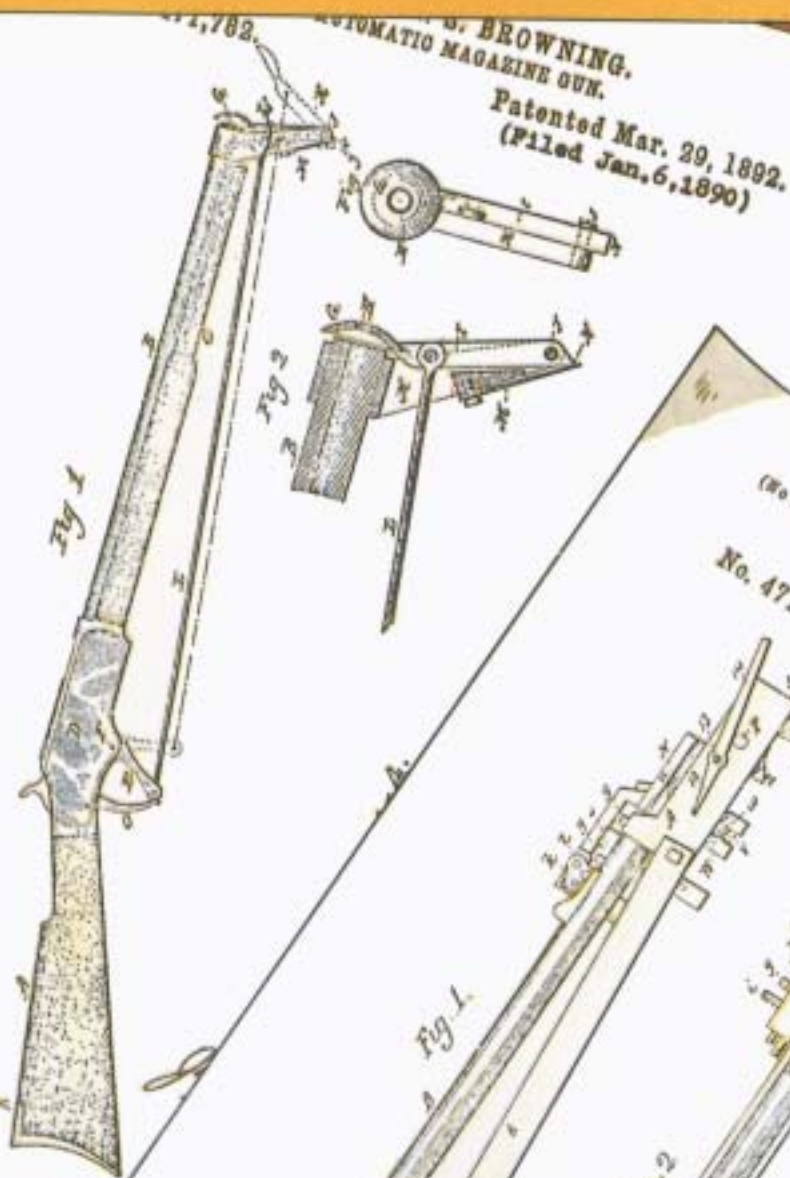

*Witnessed  
John S. ...*

*John M. Browning  
Inventor  
By ...*

AT THE TURN OF THE CENTURY THE BROWNING BROTHERS SET UP SHOP IN A NEW 2 STOREY BUILDING. J.M.B. AND HIS BROTHER ED WORK ON MORE INVENTIONS IN A SEPARATE SECTION...



HIS INVENTIVE CAPACITY IS ASTONISHING! HE IS ABLE TO BRING OUT 3 NEW WEAPONS A YEAR!



THE STORE ITSELF SELLS HUNTING AND SPORTING GOODS BOTH DIRECTLY AND BY MAIL ORDER.



J.M.B. GOES TO NEW HAVEN TWICE A YEAR TO SHOW HIS MODELS TO THE WINCHESTER COMPANY...



BUT ...

MATT, WE CAN'T GO ON LIKE THIS! BENNETT IS BUYING ALL OF MY INVENTIONS TO STOP ME FROM SELLING TO HIS COMPETITORS!

WHAT ELSE CAN YOU DO?



THE WORLD'S A BIG PLACE. MATT. BENNETT ISN'T THE ONLY BUYER ON EARTH...

YOU'RE RIGHT! WE'VE GOT TO CONTACT OTHER MANUFACTURERS!



IN THE MEANTIME, I'M GONNA GET WORKING ON MY FAVORITE IDEA ...



ING BRUS.  
OLS GUNS

... A FULLY AUTOMATIC WEAPON!



AND HE GETS DOWN TO WORK...

THE PATENT FOR A MACHINE GUN IS GRANTED IN 1891

MATT CONTACTS JOHN HALL, PRESIDENT OF THE COLT COMPANY AND ARRANGES FOR A DEMONSTRATION OF THEIR NEW INVENTION WHICH IS STILL IN THE PROTOTYPE STAGE. HALL IS SO IMPRESSED THAT HE PROMISES TO ORGANIZE A TRIAL MEETING WITH GOVERNMENT OFFICIALS...



A FEW MONTHS LATER, IN THE PRESENCE OF JOHN HALL AND TWO U.S. NAVY ORDNANCE OFFICERS, THE MACHINE GUN FIRES 1,800 ROUNDS IN 3 MINUTES WITHOUT A REST.



COLT MOD. 1895



"PEACEMAKER"

THE BROWNING MACHINE GUN COLT MODEL 1895 IS ADOPTED BY THE U.S. ARMY

THE NEXT FEW YEARS WITNESSES THE DEVELOPMENT OF THE .30 AND .50 CALIBER MODELS...



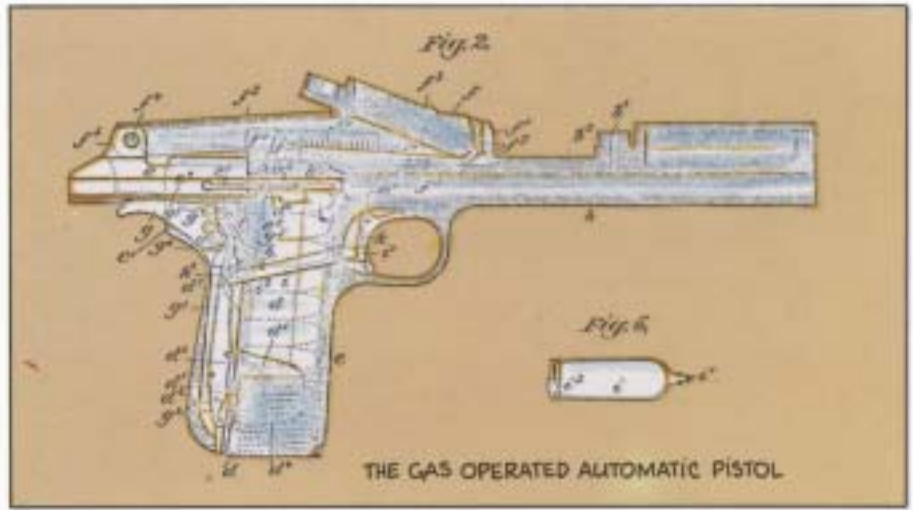

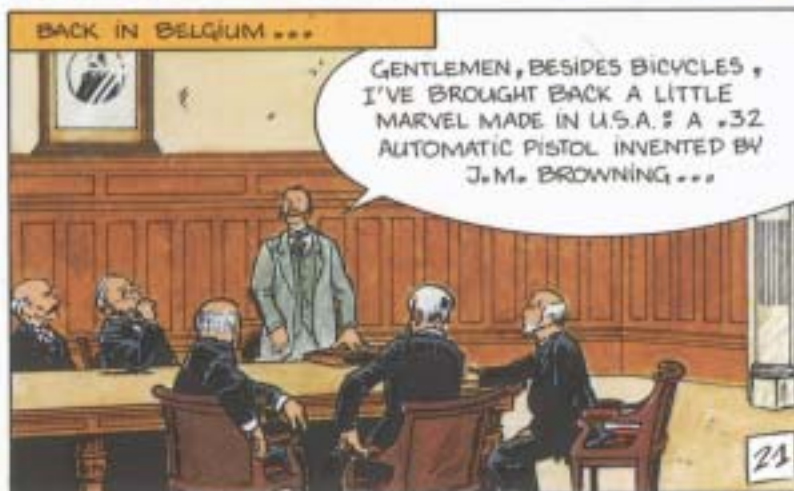
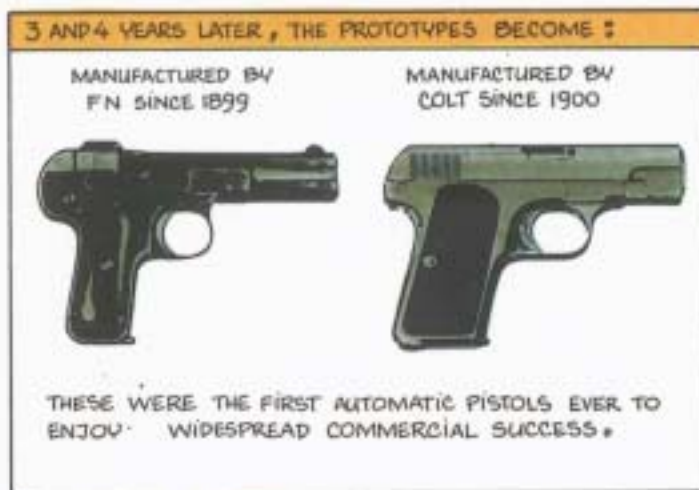



ONCE ON THE OPEN MARKET THIS WEAPON ...



FINDS UNEXPECTED FAME ...



IT WAS NOT UNTIL AFTER THE FIRST WORLD WAR THAT THE POLICE FINALLY ADOPTED THE BROWNING TO FIGHT CRIME ON A EQUAL BASIS ...



IN THE MEANTIME, SINCE 1898 J.M. BROWNING HAD BEEN WORKING ON HIS FAMOUS 5-SHOT AUTOMATIC SHOTGUN ... (SEE PAGES 1, 2 AND 3)



AS HE HAD ALWAYS DONE FOR ALL OF HIS INVENTIONS, HE STUDIED THE REACTIONS OF THE WEAPON BY FIRING THOUSANDS OF CARTRIDGES!



THE AUTOMATIC MECHANISM WORKS PERFECTLY!



IT'S A 5-SHOT FULLY AUTOMATIC AND USES THE "LONG RECOIL" SYSTEM GIVING PERFECT MECHANICAL OPERATION!



ONCE ON THE OPEN MARKET THIS WEAPON ...



FINDS UNEXPECTED FAME ...

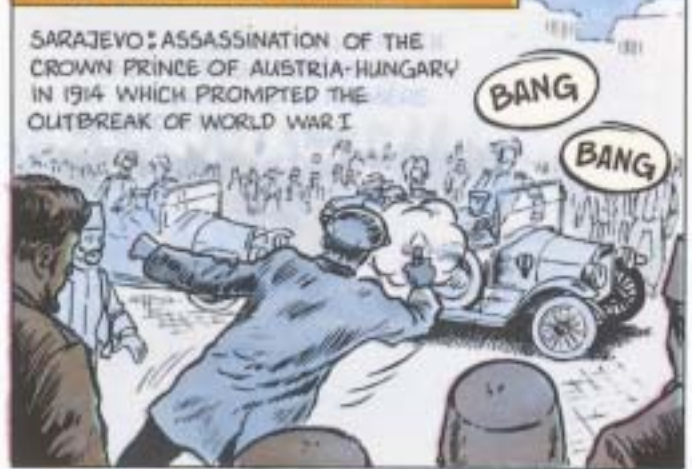

IT WAS NOT UNTIL AFTER THE FIRST WORLD WAR THAT THE POLICE FINALLY ADOPTED THE BROWNING TO FIGHT CRIME ON A EQUAL BASIS ...



IN THE MEANTIME, SINCE 1898 J.M. BROWNING HAD BEEN WORKING ON HIS FAMOUS 5-SHOT AUTOMATIC SHOTGUN ... (SEE PAGES 1, 2 AND 3)



AS HE HAD ALWAYS DONE FOR ALL OF HIS INVENTIONS, HE STUDIED THE REACTIONS OF THE WEAPON BY FIRING THOUSANDS OF CARTRIDGES!



THE AUTOMATIC MECHANISM WORKS PERFECTLY!



IT'S A 5-SHOT FULLY AUTOMATIC AND USES THE "LONG RECOIL" SYSTEM GIVING PERFECT MECHANICAL OPERATION!



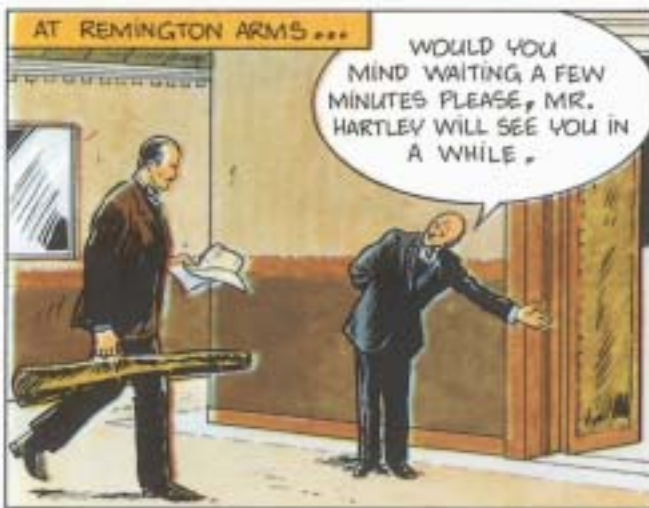
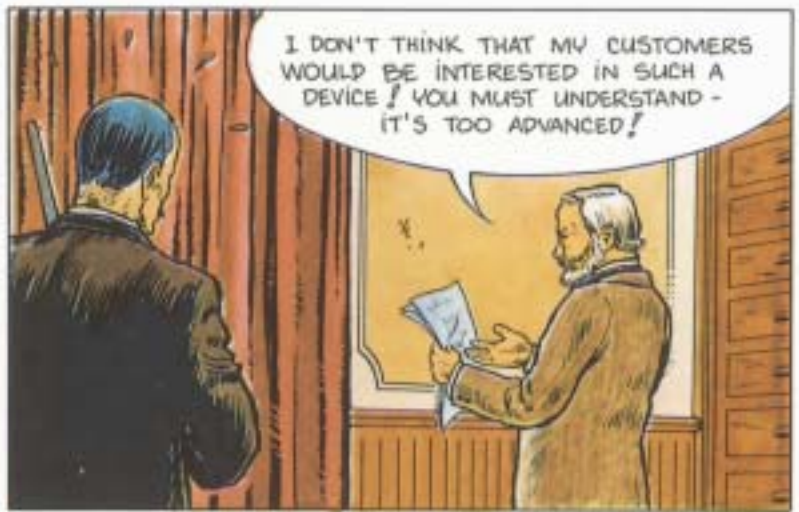



WHAT ROTTEN WEATHER!

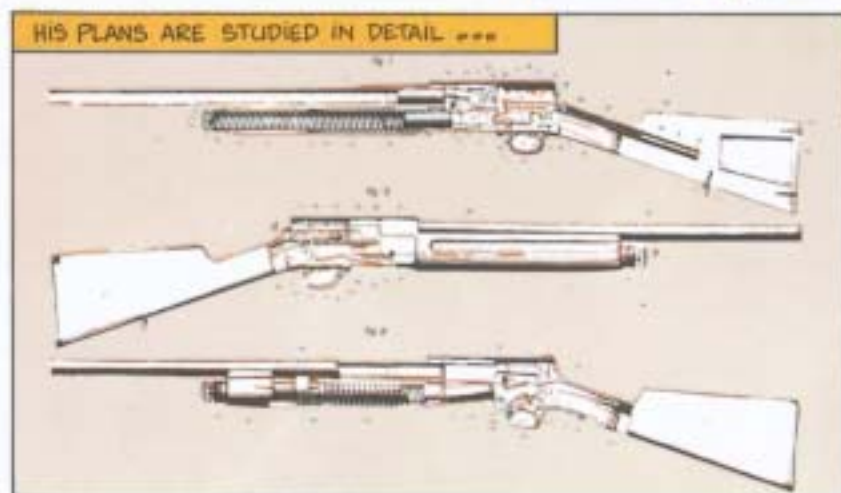

MARCH 24, 1902 AT THE FN FACTORY



WE'RE GOING TO MANUFACTURE A TRIAL MODEL SERIES. PLEASE STAY WITH US TO SUPERVISE THE PROGRESS.

IT'LL BE A PLEASURE! MR. FRENAY!



JOHN MOSES STARTS HIS APPRENTICESHIP OF THE FRENCH LANGUAGE

WHAT DO YOU CALL THIS IN FRENCH, DONNAY?

IT'S CALLED "ÉJECTEUR" MR. BROWNING



HE BECAME POPULAR AMONG THE WORKERS

"VOCHAL LI MAÏSSÉ!"



WE'LL SOON START TESTING THE FIRST TRIAL SERIES!



THIS SHOTGUN HAS JUST FIRED 40,000 ROUNDS! IT'S A SUCCESS!

BANG



I GUESS I CAN GO BACK TO OGDEN. THE GUN'S READY FOR PRODUCTION!



SO LONG FRIENDS!



PRODUCTION OF THE "5-SHOT AUTOMATIC" BEGINS AT FN. THE 10,000 SHOTGUNS ORDERED BY J.M. BROWNING FOR THE U.S.A WERE SOLD OUT IN ONE YEAR. REMINGTON STARTED MANUFACTURING THEM IN 1905. BY 1975 FN HAD PRODUCED 3 MILLION OF THESE GUNS. ARMS MANUFACTURERS THROUGHOUT THE WORLD HAVE COPIED THIS MODEL. OVER FIFTY YEARS OF GROWING POPULARITY HAVE PROVEN THE AUTOMATIC SHOT-GUN TO BE ONE OF THE MOST OUTSTANDING ACHIEVEMENTS IN THE HISTORY OF SPORTING ARMS DESIGN.

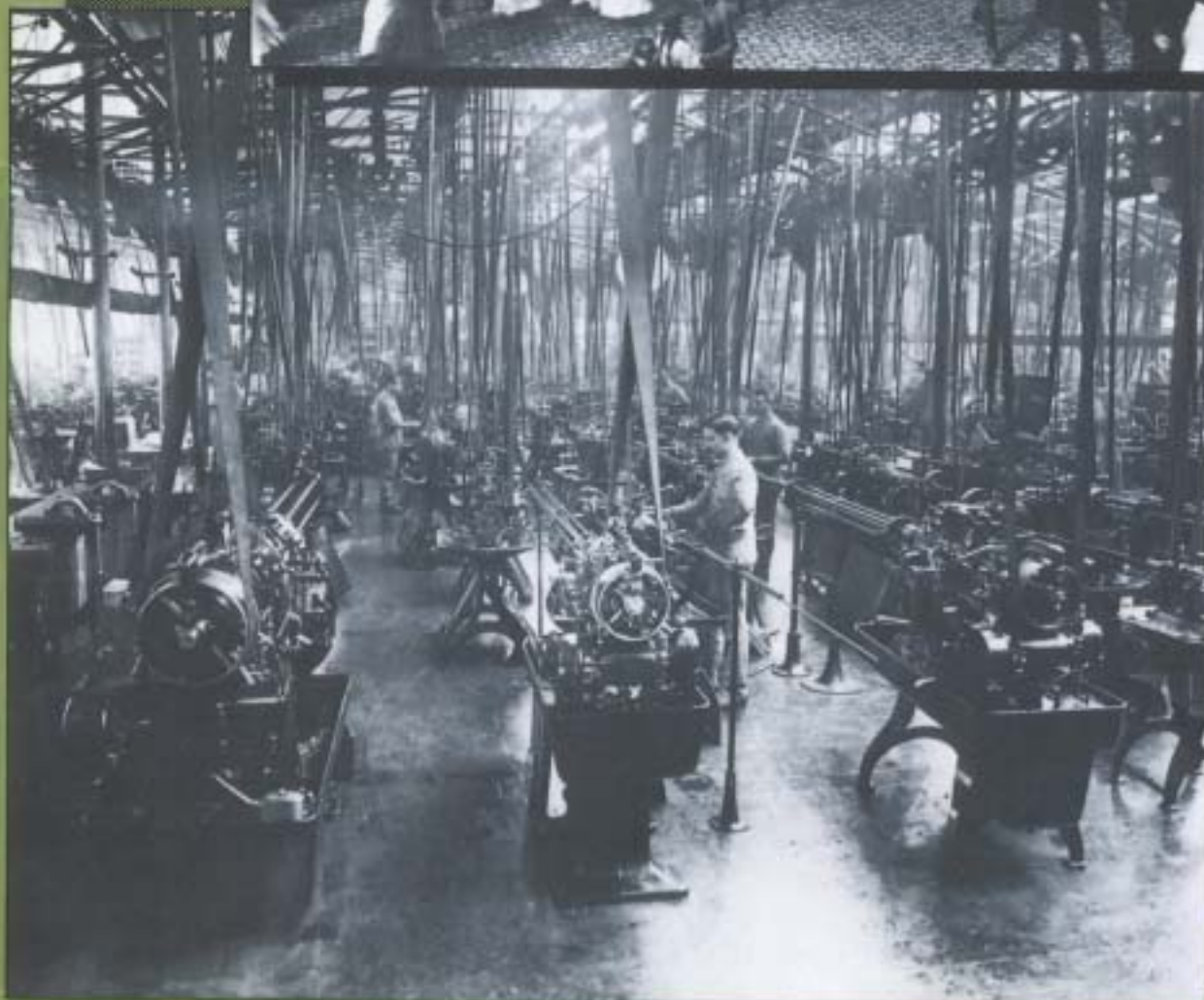

**MORE CONTRACTS WITH FN FOLLOWED !**

MODEL 1903 9MM MILITARY  
SEMI-AUTOMATIC PISTOL



MODEL 1910 9MM SEMI-  
AUTOMATIC PISTOL



1905 : MODEL VEST POCKET .25  
CALIBER SEMI-AUTOMATIC



AND THE .35 CALIBER  
AUTOMATIC HUNTING RIFLE

1914 : SEMI-AUTOMATIC .22  
CALIBER RIFLE



**1914 : BROWNING IS AWARDED THE CROSS OF KNIGHTHOOD OF THE  
ORDER OF LEOPOLD !**

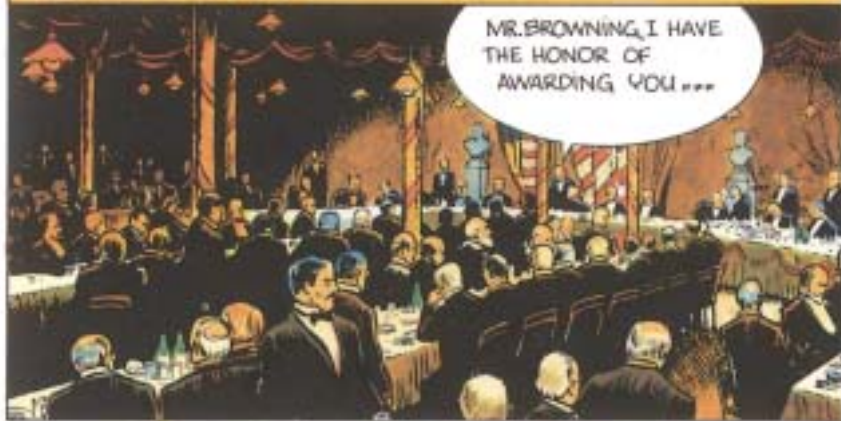

MR. BROWNING, I HAVE  
THE HONOR OF  
AWARDING YOU ...

THANK YOU, MY FRIENDS, BUT IT  
WAS YOUR COLLABORATION THAT  
HELPED ME GET THINGS DONE !  
THANKS AGAIN FOR EVERYTHING  
...



**JOHN MOSES BROWNING GOES BACK HOME TO OGDEN, UTAH - WORLD WAR I BREAKS OUT AND \*FABRIQUE  
NATIONALE D'ARMES DE GUERRE\*<sup>®</sup> IS TAKEN OVER BY THE OCCUPYING FORCES !**

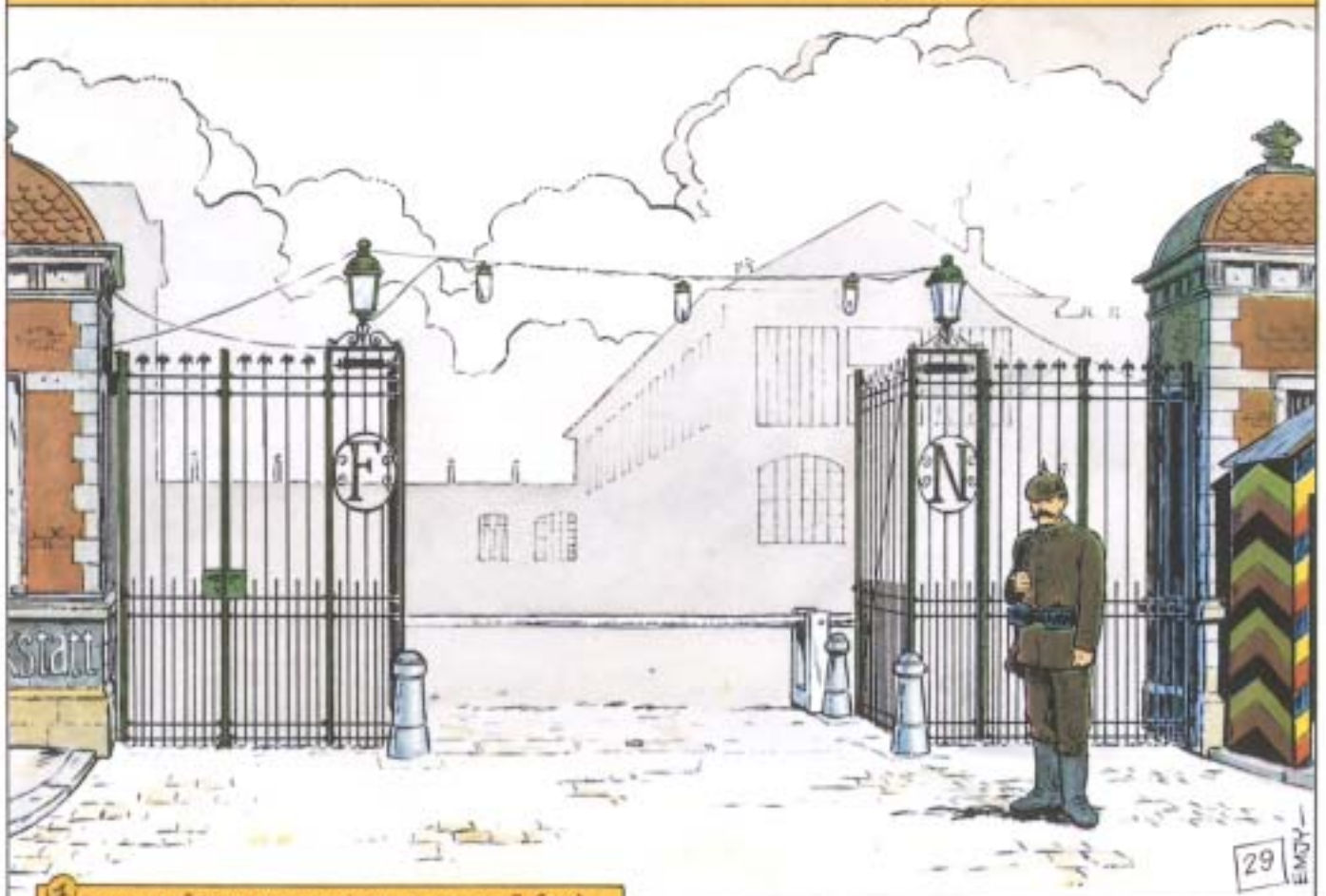

**RENAMED \*FABRIQUE NATIONALE HERSTAL\* (FN)**



JOHN MOSES BROWNING HELPS IN THE WAR EFFORT



THE .30 CALIBER MACHINE GUN IS TESTED AND ACCEPTED BY THE U.S. ARMY

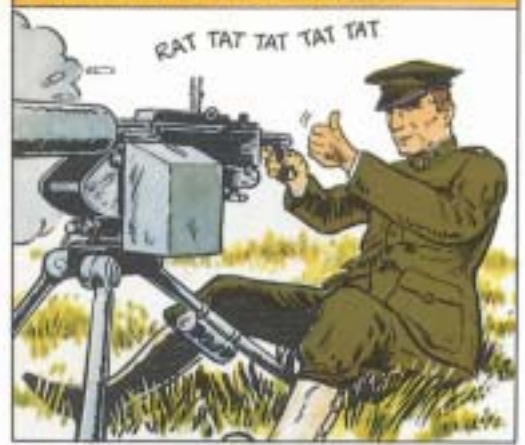

IN 1917, HE INVENTS THE B.A.R.

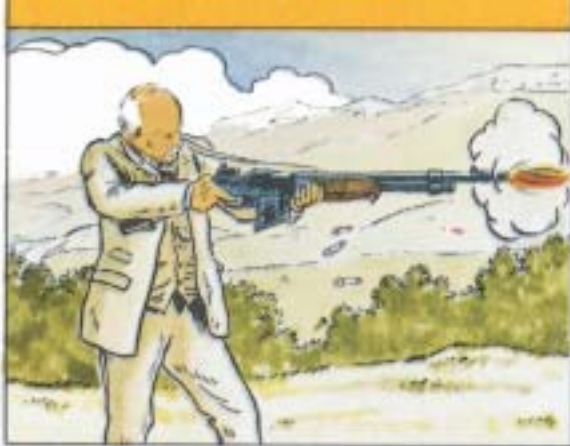

AS YOU CAN SEE \* DISASSEMBLY AND REASSEMBLY ARE BOTH FAST AND EASY !



IT'S UNBELIEVABLE, HE ASSEMBLED THE MACHINE GUN BLINDFOLDED !



LET ME TRY IT MYSELF !



TERRIFIC ! IT'S EXTRAORDINARILY SIMPLE !



IN FRANCE, LIEUTENANT VAL A. BROWNING, J.M.B.'S SON IS AN ARMY INSTRUCTOR FOR THE B.A.R.



IT'S OK MEN! NOW SHOW THEM WHAT IT CAN DO ON THE FRONT LINES! DISMISSED!



THE B.A.R. BLASTS AWAY VICTORIOUSLY ON THE FRONT LINES,



AND SO DOES THE .30 CALIBER MACHINE GUN.



BACK IN OGDEN...



YOUR .50 CALIBER MACHINE GUN IS READY! HOW DID YOU DO IT?

ONE DROP OF GENIUS IN A BARREL OF SWEAT WROUGHT THIS WEAPON!



IT'S A PITY YOUR .50 CALIBER MACHINE GUN DIDN'T COME OUT A FEW YEARS EARLIER TO HELP OUR BOYS IN THE TRENCHES!

THANK GOD THE WAR IN EUROPE IS ALMOST OVER!

GETTING IT INTO PRODUCTION WOULD TAKE TOO LONG!

THE WAR IS OVER ...



EH, DONNAY "LI MAÏSSE EST RIVNOLU!"



IT'S GREAT TO SEE ALL OF YOU AGAIN ...

ONCE AGAIN J.M.B. IS BACK IN HERSTAL ...



VAL, MY BOY, STAY IN LIEGE, YOU'LL BE THE TECHNICAL ADVISER FOR OUR COMPANY!

SURE THING, DAD!

HEY DONNAY, THE MASTER IS BACK! "

J.M.B. MAKES MANY TRIPS BETWEEN THE U.S.A. AND BELGIUM

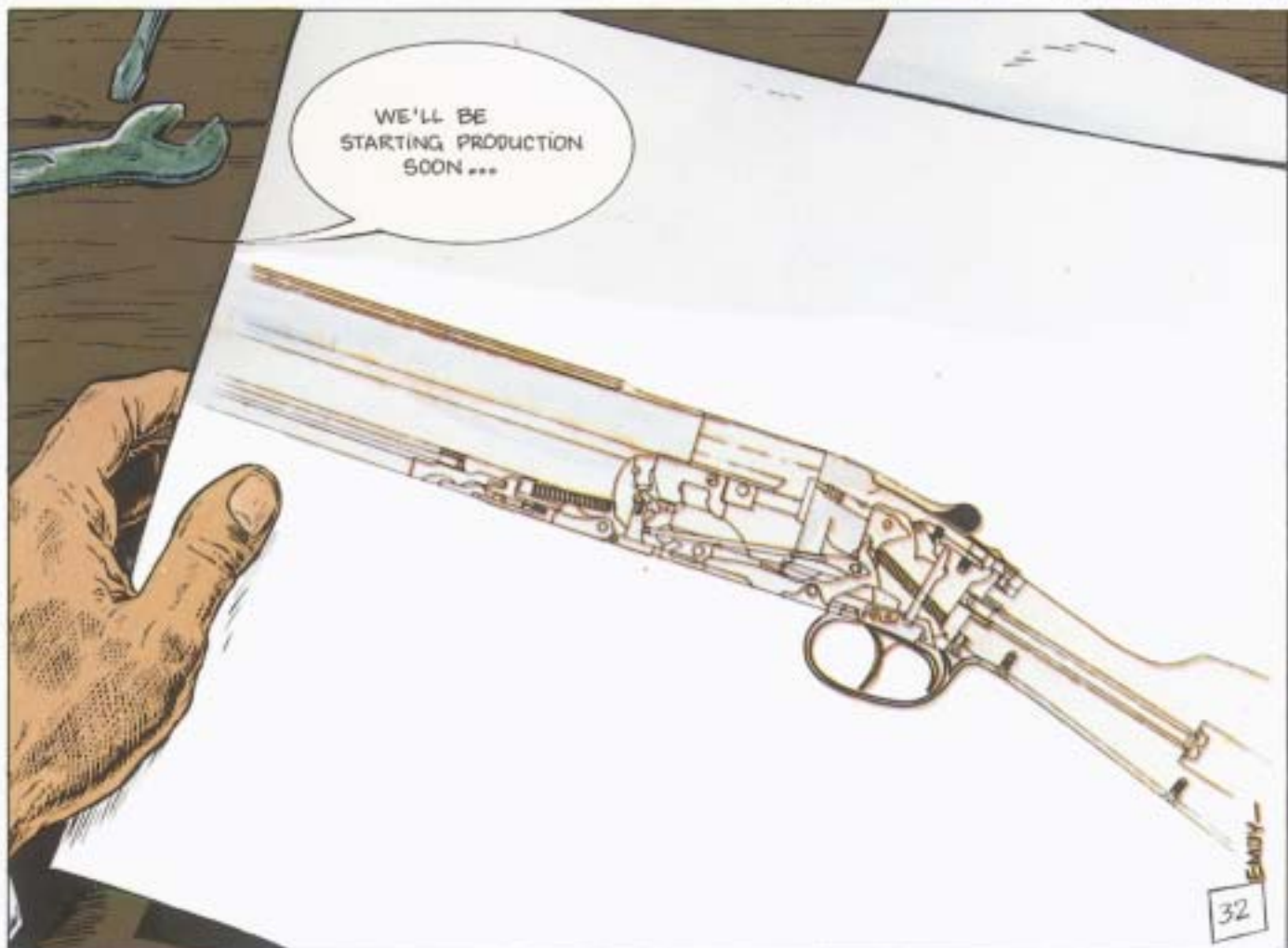



AND SO JOHN MOSES BROWNING, THE GREAT INVENTOR OF FIREARMS, LAID DOWN HIS TOOLS ON NOVEMBER 26, 1926

A DAY OF MOURNING WAS PROCLAIMED AT FN. THE ENTIRE PERSONNEL PAID LAST RESPECTS TO THE MAN WHO LAY IN STATE IN THE FN BOARD ROOM.



**THE END**

↑ TO THE MEMORY OF JOHN M. BROWNING 1855-1926... THIS IS THE PLACE WHERE, THIRTY YEARS PREVIOUSLY HE CAME FROM OGDEN TO HAVE HIS FIRST AUTOMATIC PISTOL MANUFACTURED AND WHERE, ON THE TWENTY-SIXTH OF NOVEMBER, 1926, WHILE HE WAS BUSILY EN- GAGED AT WORK, DEATH OVERTOOK THE GREATEST FIRE- ARMS INVENTOR THE WORLD HAS EVER KNOWN.

THE "BROWNING ARMS COMPANY" WHICH WAS FOUNDED IN OGDEN, UTAH ON NOVEMBER 14, 1927 (RENAMED "BROWNING" IN 1972 ) NOW HAS ITS HEAD OFFICE IN MORGAN, UTAH, AND IS CONTINUING THE WORK OF THE GREAT INVENTOR BY BOTH CREATING AND COMMERCIALIZING NEW FIREARMS, AS WELL AS BY MANUFACTURING AND SELLING ALL KINDS OF SPORTING GOODS.



FN WHICH HAS MANUFACTURED BROWNING FIREARMS SINCE 1926 BECAME CLOSELY ASSOCIATED WITH THE AMERICAN COMPANY IN 1977 ON BOTH THE TECHNICAL AND COMMERCIAL LEVELS.



A hunting trip in Jackson Hole, Wyoming,  
attended by John Moses Browning and his brother Matt , about 1910.



John Moses Browning at eighteen. He was already in charge of his father's shop. Everybody called him "John Mose".



John Moses Browning's parents.



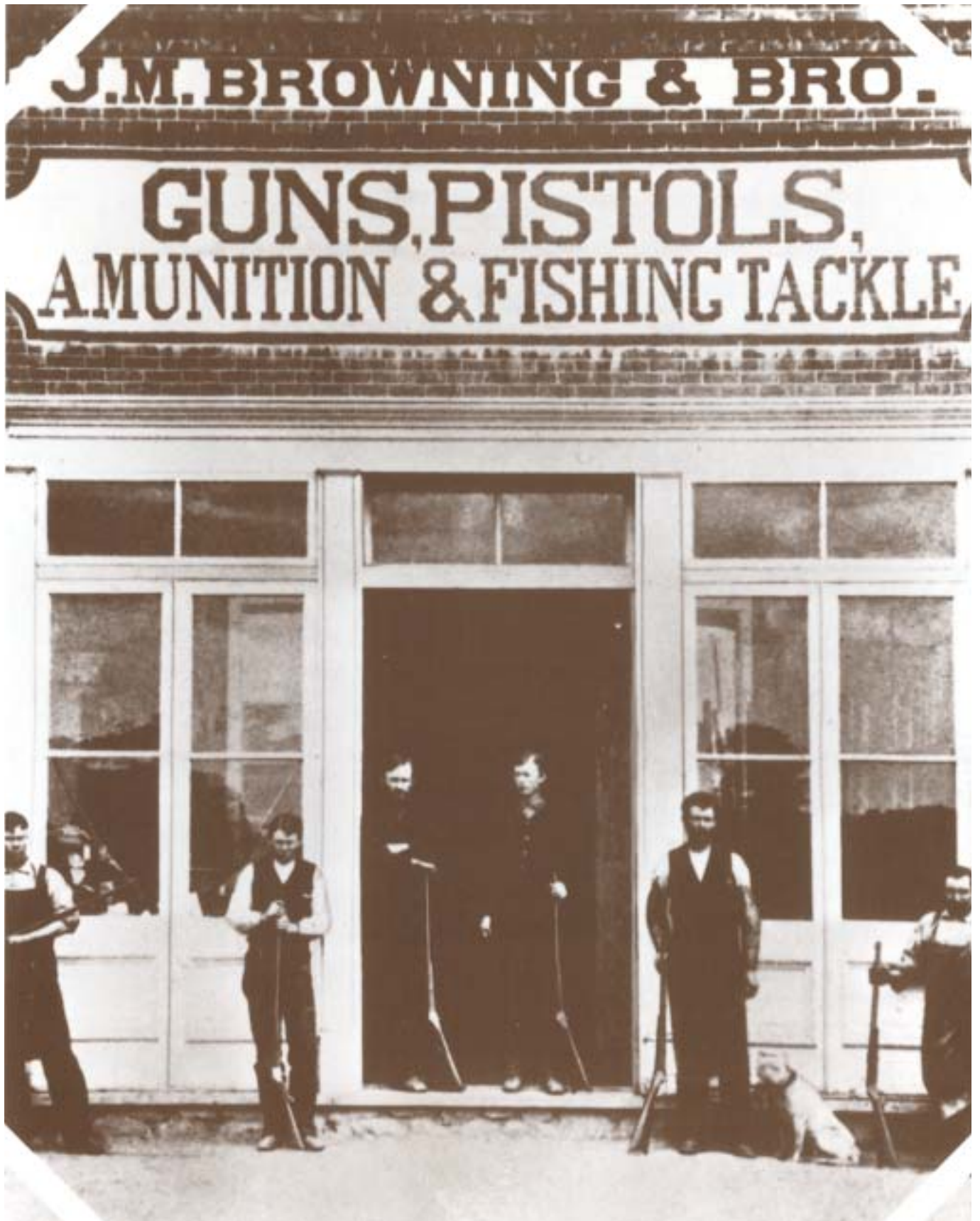

The Browning Brothers factory, Ogden, Utah Territory, about 1882.  
Left to right : Sam, George, John Moses and Ed Browning,  
with Frank Rushton, an English gunmaker.



The four Utah shooting champions in 1892. The four B's are from left to right : G.L Becker, John Moise Browning, A.P. Bigelow and Matthew S. Browning.



Formal portrait of John Moses Browning with model 1895 automatic machine gun.  
The background scene is part of the photography studio tradition.



Lieutenant Val A. Browning, in 1917, demonstrating the use of the Browning automatic rifle invented by his father.



John Moses Browning with his automatic shotgun photographed at FN shortly before his death (1926).